

CoRound Seal: Minimal-Sealant Hermetic Hygienic PVC Coving System

CoRound Seal: Advanced hermetic PVC system with flexible sealing lips that adapt perfectly to insulated panels or drywall surfaces for minimal-sealant junctions. Eliminates most contamination risks, simplifies cleaning and maintenance, resists chemicals and extreme temperatures, ensuring superior hygiene and compliance in food processing, cleanrooms, walk-in coolers/freezers, and cold storage facilities.

Key Features of CoRound Seal:

- Flexible sealing lips deliver minimal-sealant hermetic seals on insulated panels (no silicone required on coving profiles; thin bead recommended on skirting/channels), eliminate contamination risks, simplify cleaning, resist chemicals/temperatures, and ensure superior hygiene compliance.
- Channels water downward, eliminating risks of infiltration and pooling for superior hygiene and durability.

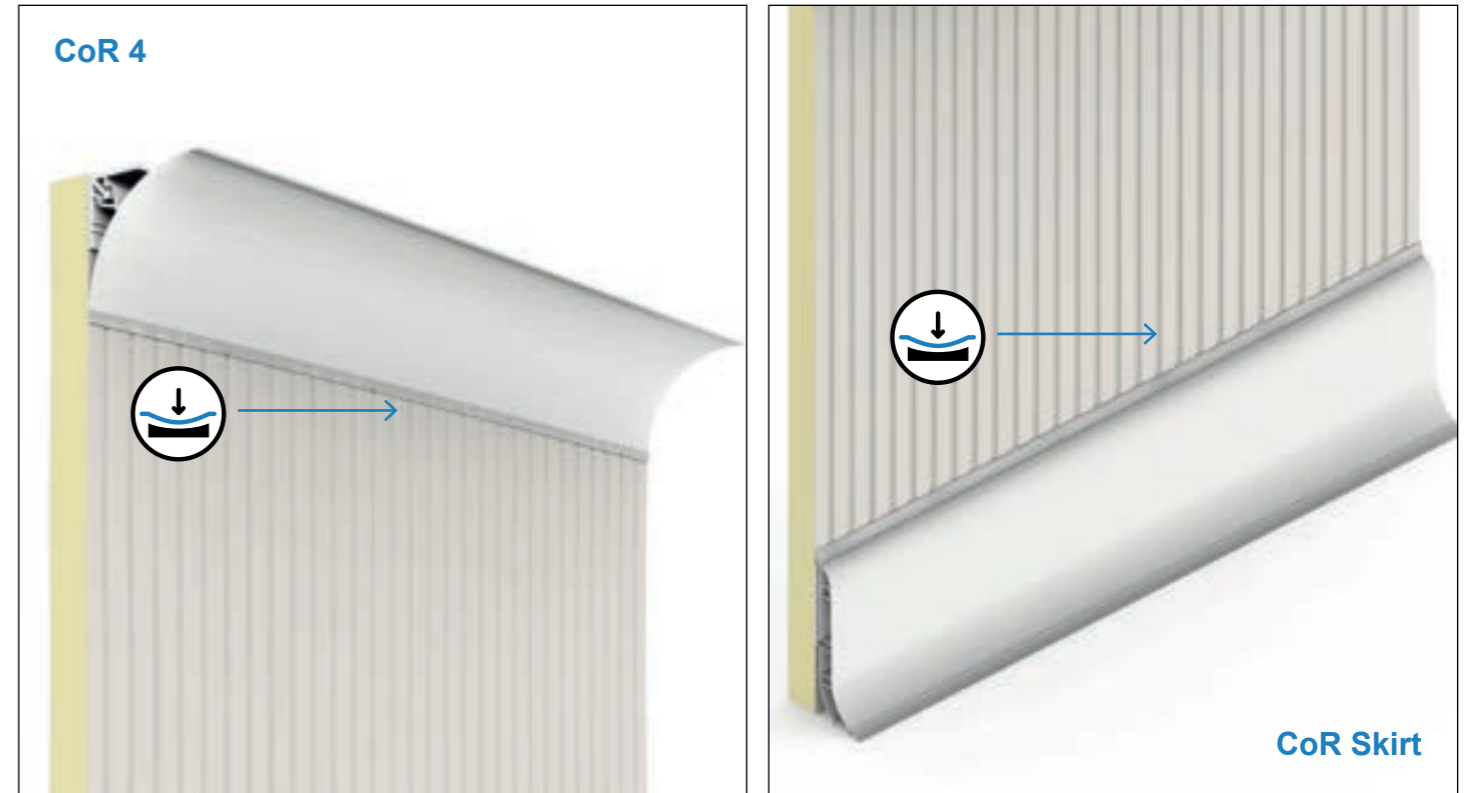
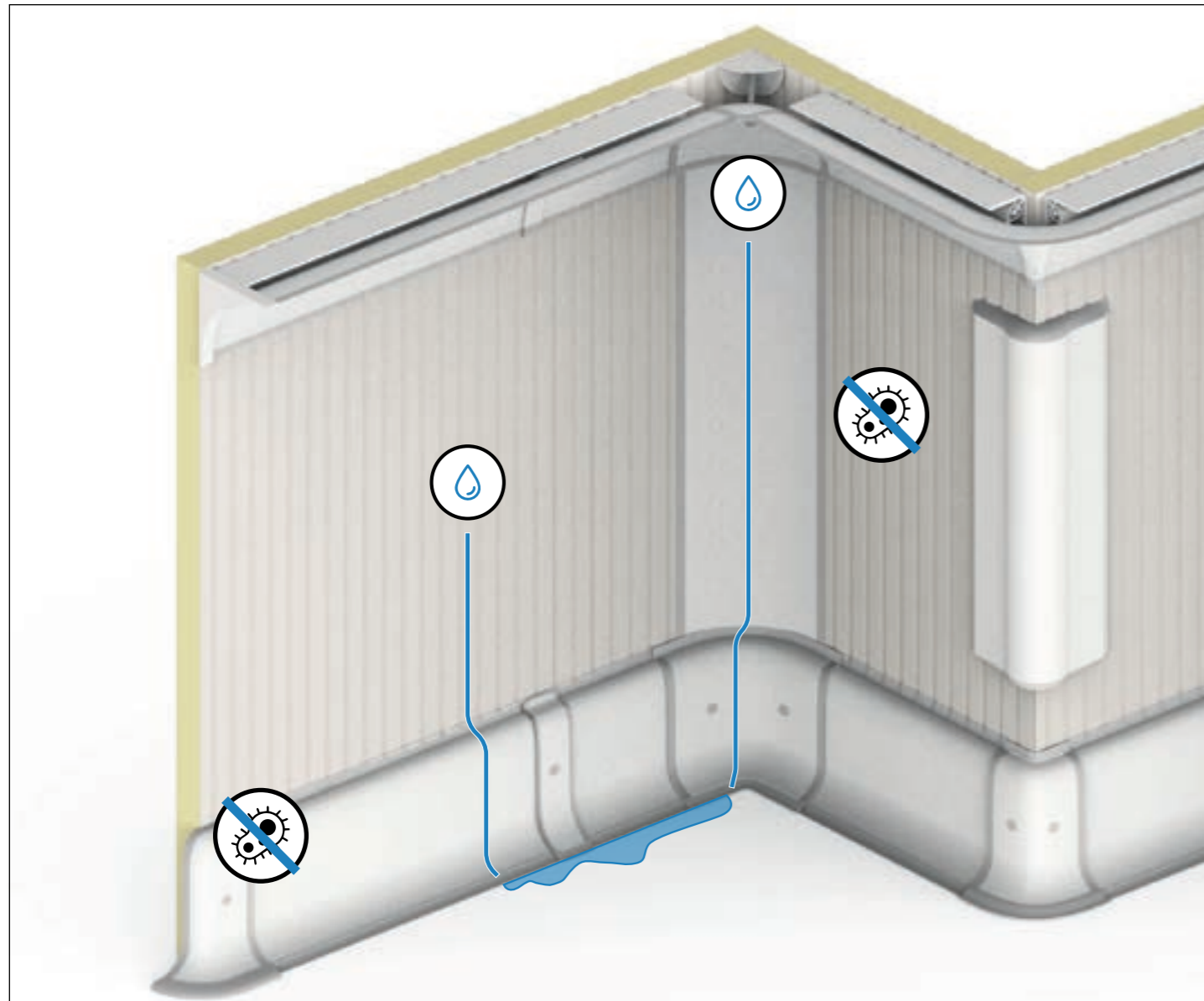

Without CoRound: traditional silicone sealant on metal flashings quickly turns black, attracting dirt, mold and bacteria.

These hidden contamination spots are almost impossible to clean thoroughly, compromising hygiene in food processing and cold storage facilities. With CoRound hermetic PVC coving: no silicone needed, flexible sealing lips create smooth, seamless, easy-to-clean surfaces that stay pristine for years.



CoRound Seal: Complete Seamless Hermetic System

The CoRound Seal Hermetic PVC System delivers superior hygiene and airtight sealing for walk-in coolers/freezers, food processing plants, cleanrooms, commercial kitchens, and pharmaceutical facilities. Its innovative profiles feature flexible sealing lips that conform perfectly to insulated panels and drywall surfaces, **requiring minimal or no additional sealants** (no silicone on coving; thin bead recommended on skirting/channels).

This hermetic design creates a gap-free barrier that prevents infiltration of moisture, dirt, and bacteria—even under the toughest industrial conditions—while ensuring easy cleaning and full compliance with **FDA, USDA, CFIA, and cGMP** standards. The system is completed by a range of specialized complementary accessories—including 3-way internal corners, external corners, end caps, joints, and termination profiles—all precision-engineered to deliver seamless transitions and a smooth, continuous hygienic surface.

Key Features

- Flexible sealing lips for automatic, perfect adaptation to panel surfaces
- Concealed fixings for a clean, professional aesthetic
- **Minimal-sealant installation** saves time and eliminates ongoing maintenance
- Food-safe, chemical-resistant PVC compliant with strict hygiene regulations
- Fully compatible with drainage channels for complete floor-wall sealing

Customer Benefits

- Faster, cleaner installation that reduces labor costs
- Enhanced hygiene with minimal risk of microbial contamination
- Lower long-term maintenance thanks to durable, non-porous surfaces
- Improved energy efficiency by preventing cold bridges and maintaining thermal integrity
- Operating range: **-4°F to +140°F** (-20°C to +60°C)

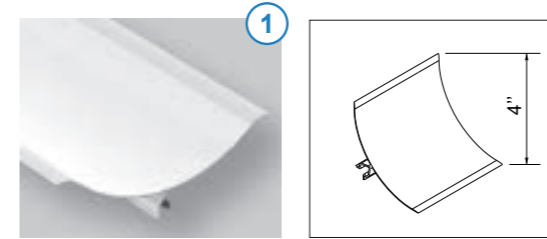
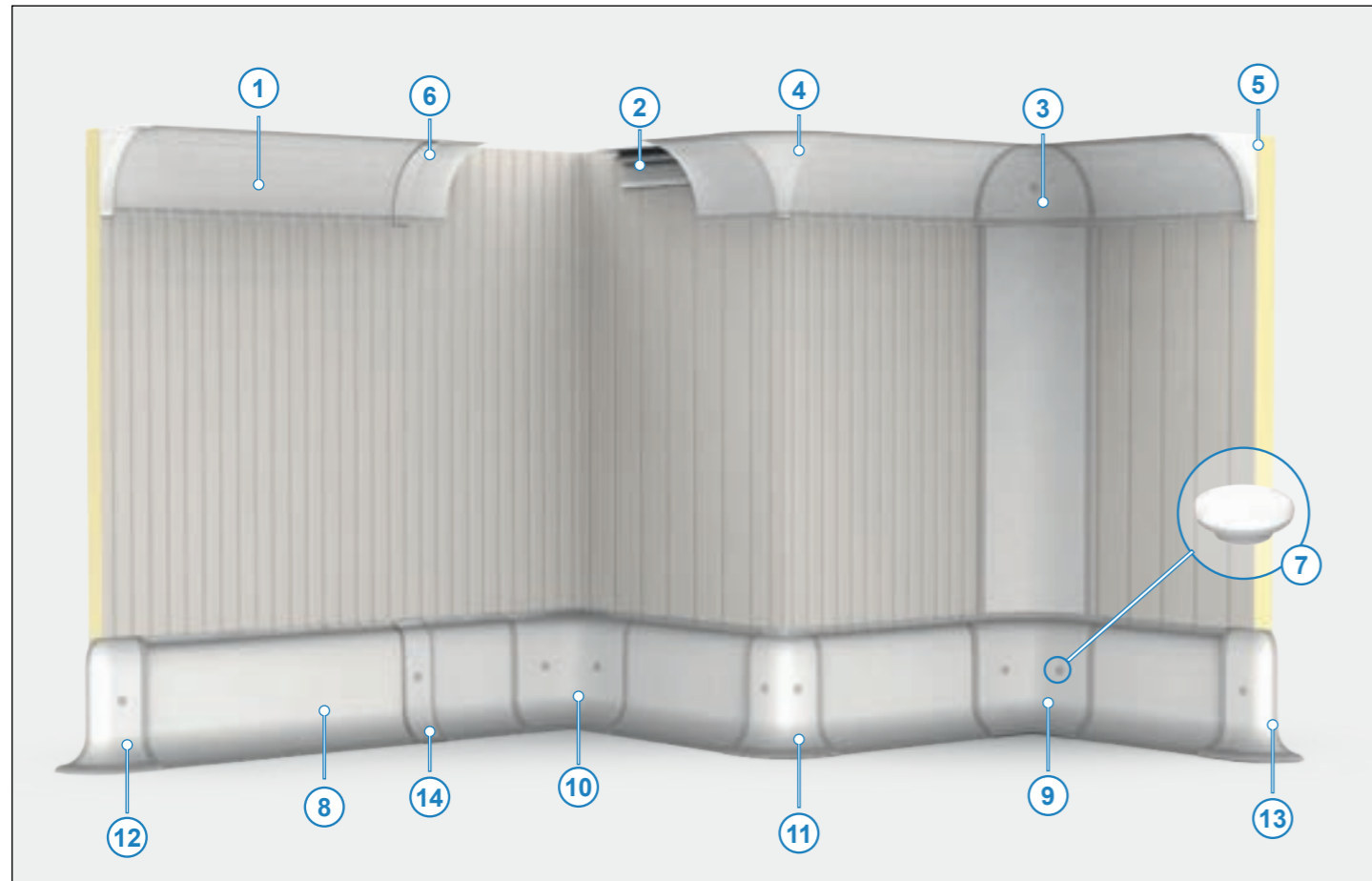

CoR 4: Premium 4" radius curved coving with flexible sealing lip creates seamless, hermetic junctions at wall-to-wall or wall-to-ceiling transitions on insulated panels. No sealant required thanks to automatic adaptation. Prevents residue buildup, eliminates bacterial risks, and simplifies cleaning perfect for high-hygiene environments like cold storage, food processing, and cleanrooms.

Length: 13 ft (4,000 mm) Packing: 25 pcs/box Colors: Pure White 9010, Sand White 9002, Light Grey 9023. Temperature range: -4°F to +140°F.

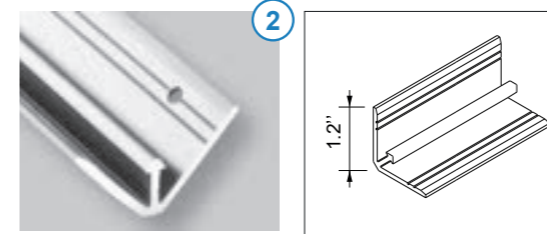

CoR Base: Factory pre-drilled PVC support profile (aluminum option available) for quick, precise installation of CoR 4 coving. Ensures secure placement, reduces labor time, and provides a stable base for hermetic sealing on irregular surfaces.

Length: 13 ft (4,000 mm) Packing: 25 pcs/box.

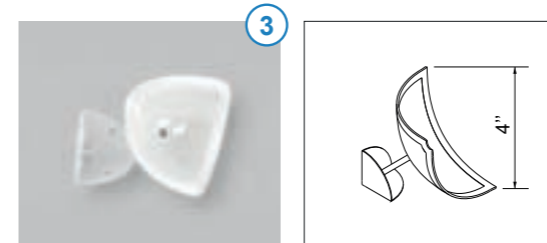

CoR 4 S 3-Way Internal Corner: Advanced 3-way internal corner with flexible sealing edges adapts perfectly to CoR 4 profiles, delivering a tight, sealant-free hermetic seal. Eliminates gaps for dirt/moisture, ensures easy cleaning—ideal for food facilities, cleanrooms, and pharmaceutical areas.

Packing: 100 pcs/box Colors: Pure White 9010, Sand White 9002.

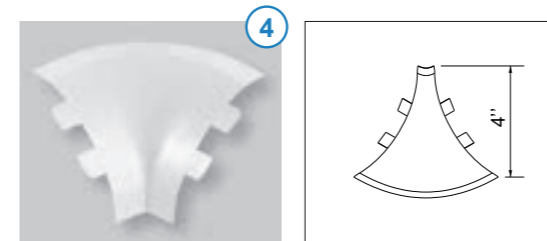

CoR 4 2-Way External Corner: Precision external corner profile seamlessly joins CoR 4 coving at outer angles, maintaining hermetic integrity and a clean, professional finish in high-sanitation installations.

Packing: 100 pcs/box Colors: Pure White 9010, Sand White 9002

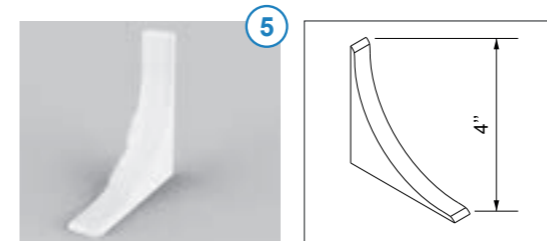

CoR 4 End: Termination cap provides a polished, hygienic closure at CoR 4 coving edges, preventing exposure and ensuring a smooth, easy-to-clean endpoint.

Packing: 100 pcs/box Colors: Pure White 9010, Sand White 9002

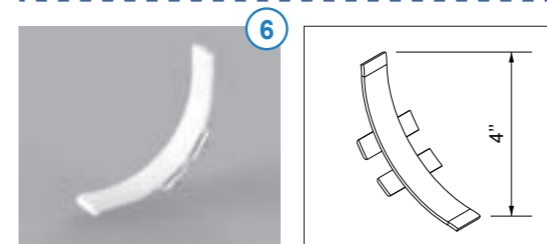

CoR 4 Joint: Straight-line connector ensures perfect alignment and stability between CoR 4 sections, with flexible edges for hermetic, aesthetic joints without sealants.

Packing: 100 pcs/box Colors: Pure White 9010, Sand White 9002, Light Grey 9023.

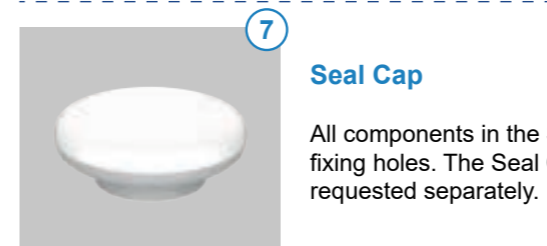

Seal Cap

All components in the Seal version are equipped with a Seal Cap to prevent dirt from accumulating near the fixing holes. The Seal Cap is included as standard in the shipment of Seal components, and can also be requested separately.

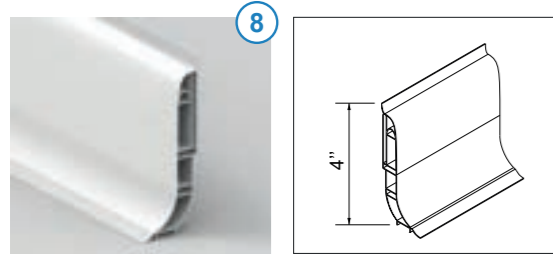

CoR Skirt S: Sanitary skirting in rigid PVC with flexible sealing lips and snap-on cover strip for concealed fixings – opens for easy access during installation, snaps closed for a seamless, hygienic wall-floor transition while adapting to panels to prevent contamination. *Thin bead of neutral food-grade silicone recommended at floor joints for optimal waterproofing in high-moisture areas.*

Length: 13 ft (4,000 mm) - Packing: 10 pcs/box
Colors: Pure White 9010, Sand White 9002.

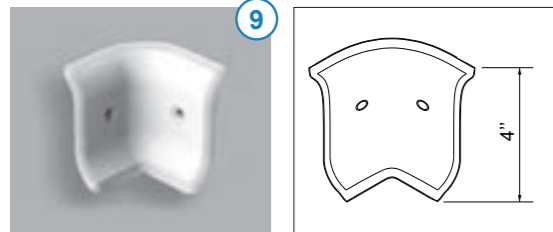

CoR Skirt S 3-Way Internal Corner: Advanced 3-way internal corner with flexible sealing edges seamlessly connects CoR Skirt sanitary skirting and CoR 4 coving at complex internal junctions. Delivers tight, sealant-free hermetic seals, prevents dirt/moisture buildup, and ensures easy cleaning. *Thin bead of neutral food-grade silicone recommended at floor joints for optimal waterproofing in high-moisture areas.*

Packing: 50 pcs/box
Colors: Pure White 9010, Sand White 9002.

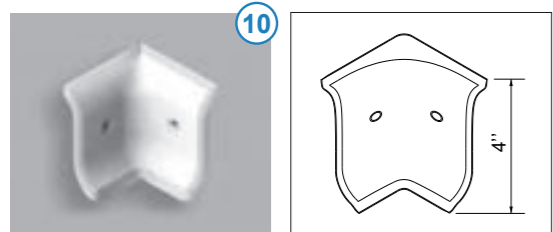

CoR Skirt S 2-Way Internal Corner: Precision 2-way internal corner profile with flexible edges joins CoR Skirt sections at inner angles (independent from coving). Creates gap-free, hermetic joints that eliminate contaminant risks and provide a continuous, easy-to-clean hygienic surface. *Thin bead of neutral food-grade silicone recommended at floor joints for optimal waterproofing in high-moisture areas.*

Packing: 50 pcs/box
Colors: Pure White 9010, Sand White 9002.

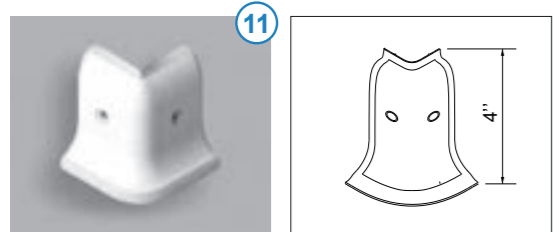

CoR Skirt S 2-Way External Corner: External 2-way corner with flexible sealing lips seamlessly connects CoR Skirt around outer corners. Ensures hermetic integrity, no exposed joints, and prevents bacterial/dirt accumulation—delivering a professional, durable finish. *Thin bead of neutral food-grade silicone recommended at floor joints for optimal waterproofing in high-moisture areas.*

Packing: 50 pcs/box
Colors: Pure White 9010, Sand White 9002.

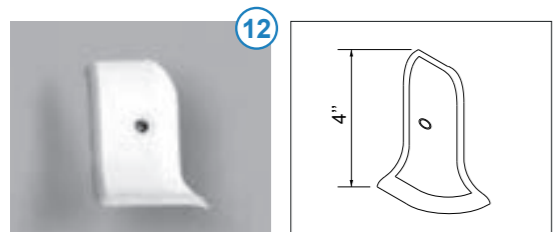

CoR Skirt S End Right: Right-side termination cap featuring flexible sealing edges adapts perfectly to CoR Skirt for a tight, hygienic endpoint closure. Prevents entry of dirt/moisture, enhances sanitation, and provides a clean, professional appearance. *Thin bead of neutral food-grade silicone recommended at floor joints for optimal waterproofing in high-moisture areas.*

Packing: 100 pcs/box
Colors: Pure White 9010, Sand White 9002.

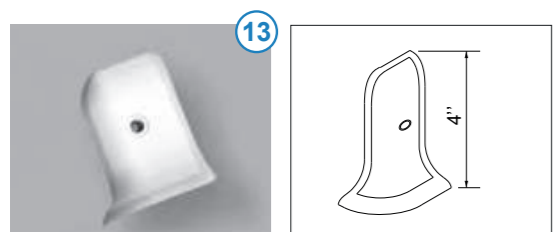

CoR Skirt S End Left: Left-side termination cap with flexible sealing edges conforms precisely to CoR Skirt, delivering secure, hermetic closure at skirting ends. Blocks contaminants, boosts durability, and maintains a polished, easy-to-clean finish. *Thin bead of neutral food-grade silicone recommended at floor joints for optimal waterproofing in high-moisture areas.*

Packing: 100 pcs/box
Colors: Pure White 9010, Sand White 9002.

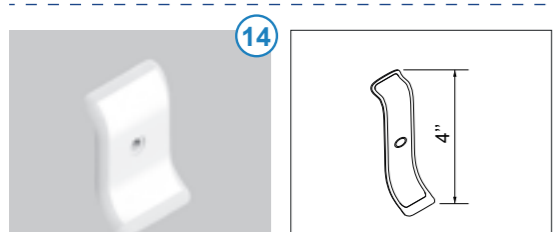

CoR Skirt S Joint: Straight-line connector with soft flexible edges joins CoR Skirt sections for perfect alignment and hygienic continuity across large walls. Ensures sealant-free seals; includes TH caps for easy installation. *Thin bead of neutral food-grade silicone recommended at floor joints for optimal waterproofing in high-moisture areas.*

Packing: 100 pcs/box
Colors: Pure White 9010, Sand White 9002.



During washdowns, the curved design of CoRound CoR 4 drives water downward along the profile, ensuring controlled drainage to the floor and preventing pooling and infiltration.

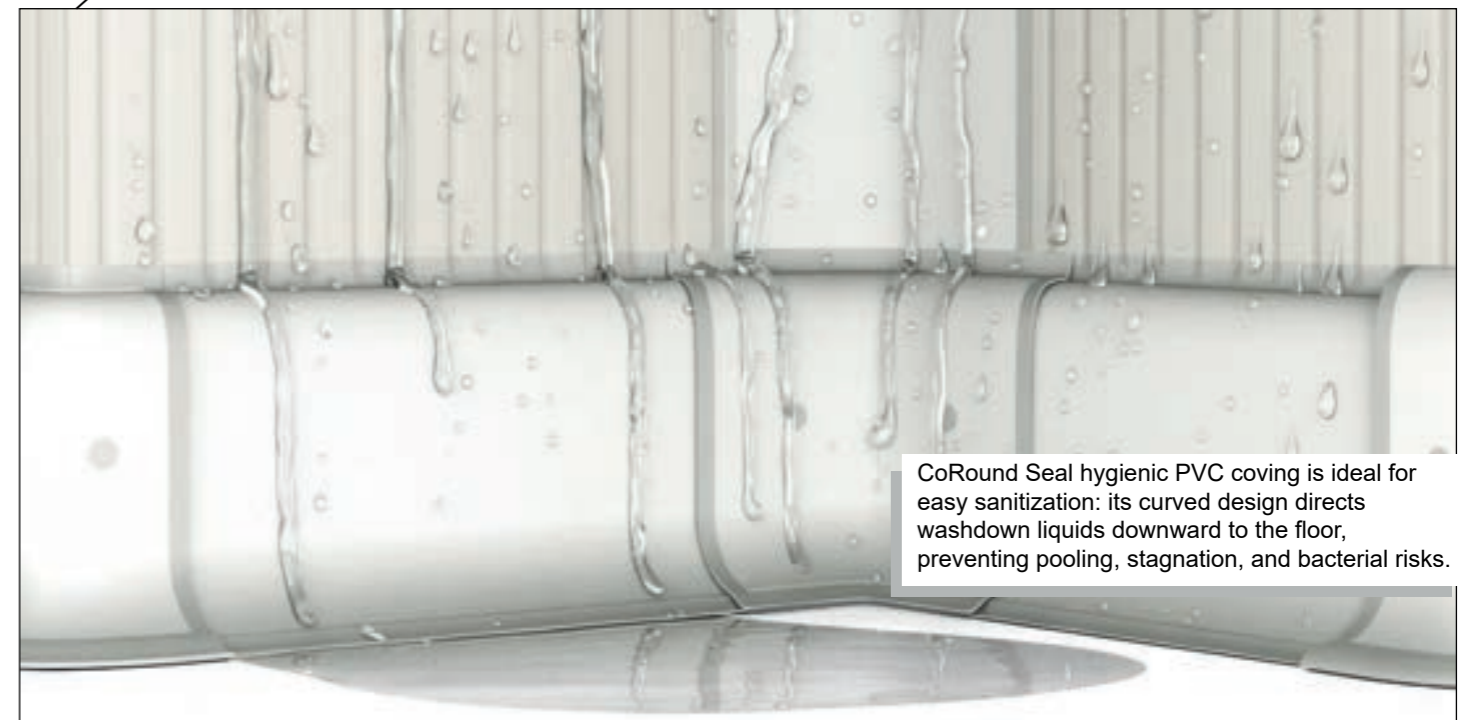

CoRound Seal hygienic PVC coving is ideal for easy sanitization: its curved design directs washdown liquids downward to the floor, preventing pooling, stagnation, and bacterial risks.